

EZ26 SERIES

THRU-THE-WALL/BUILT-IN AIR CONDITIONERS

PRODUCT INFORMATION



Available two-stage electric heat for energy savings!!

Highest Efficiency

- In real-world conditions, the modulating inverter chassis means inefficient start/stop of the compressor is eliminated.

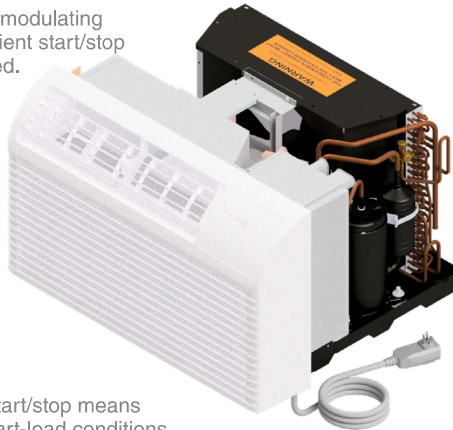

Incredibly Quiet

- Inverter compressor, condenser fan and evaporator fan slow to match cooling and heating demand of room, reducing operating sound levels.
- Elimination of compressor start/stop means the room is much quieter in part-load conditions



Consistent Dehumidification

- Modulating inverter technology ensures a cold condensing evaporator coil in part-load to keep comfortable humidity levels, eliminating clamminess in humid conditions.

The EZ26 Series Inverter Heat Pump incorporates state-of-the-art inverter technology, and are designed and manufactured for new construction or the replacement of 26" packaged terminal air conditioning units (Amana PB Series 26" unit, the GE AJ Series 26" unit, the Friedrich 27" Wallmaster unit* and the Fedders 27" unit*) in an existing building. The technology is the culmination of years of research to develop a PTAC to clearly lead the market with the low energy consumption and low sound levels. Dramatic energy savings and sound reduction is achieved by modulating the output of the PTAC to match the cooling or heating demands of the room, eliminating costly and noisy compressor cycling. This product is designed for individually-zoned, comfort-controlled heating and cooling. Standard warranty is a one year parts and labor including five year sealed system part only warranty or a two year parts only including a five year sealed system part only warranty.

(* requires kit #4090846)

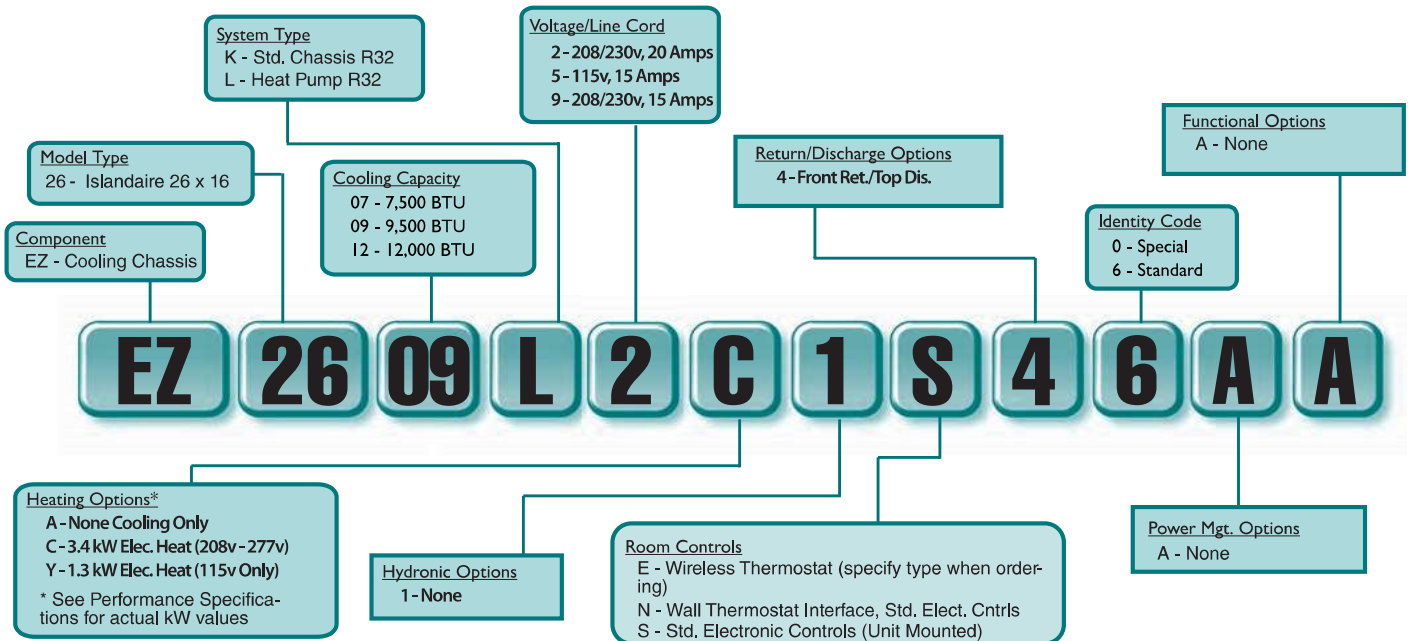

500 Middle Country Road, St. James, NY 11780 • 1-800-886-2759

e-mail: sales@islandaire.com • www.islandaire.com

Ph: 631-471-2900 • Fax: 631-471-2913

6140622 Rev. - (11/13/25)

EZ26 SERIES

THRU-THE-WALL/BUILT-IN AIR CONDITIONERS

PRODUCT INFORMATION



EZ26 Inverter: The Benefits of Inverter Technology

The EZ Series 26 Inverter Heatpump incorporates state-of-the-art inverter technology not found in any other PTAC, yet it fits into standard 26" x 16" PTAC wall sleeves. The technology is the culmination of years of research to develop a PTAC to clearly lead the market with the lowest energy consumption, most consistent dehumidification, best conditioned air and the lowest sound levels.

Although published EER's will be similar to other PTACs, based on laboratory testing simulating real-world installations, up to a 30% reduction in energy consumption can be expected with the Islandaire EZ26 Series PTAC when compared to other PTACs! Dramatic energy savings and sound reduction is achieved by modulating the output of the PTAC to match the cooling or heating demands of the room, eliminating costly and noisy compressor cycling.

Non-Inverter PTACS
Run the compressor at full RPM or zero RPM (on or off). The on/off compressor cycling in part-load conditions wastes substantial amounts of electric power.

EZ26 Inverter PTACS
Slow the compressor RPM to match the part-load cooling or heating power required. A substantial reduction in power consumption occurs

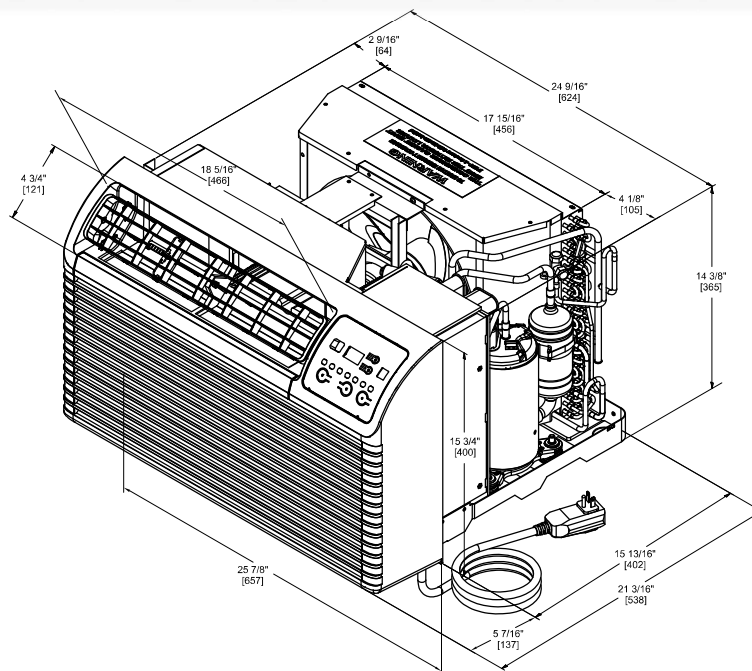
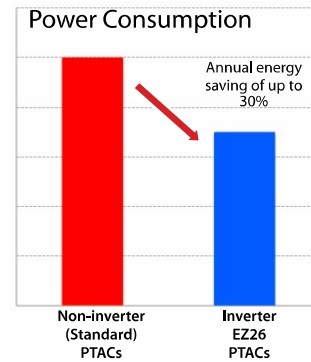
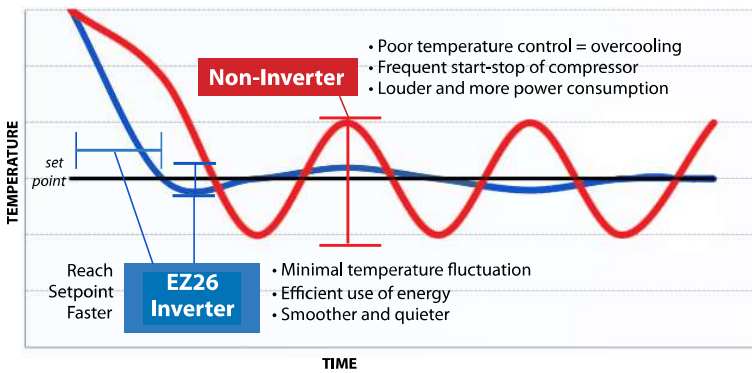

*Islandaire has a policy of continuous improvement of its products and reserves the right to change the materials and specifications without notice.

EZ26 SERIES

THRU-THE-WALL/BUILT-IN AIR CONDITIONERS

PRODUCT INFORMATION



WALL SLEEVE

PART NUMBER	DESCRIPTION	APPROX WT.	DIMENSIONS		
			DEPTH	WIDTH	HEIGHT
Consult Factory	Custom Wall Sleeves available for all building types/wall thicknesses	-	-	-	-
2401253-08	EZ26 Wall Sleeve Assembly, Break Down	32 lbs.	16.75"	26.00"	15.75"
4090846	EZ26 Sleeve Adapter Kit, converts Friedrich WSC and Fedders BSAODC 27" wide sleeves to use EZ26 unit	7 lbs.	1.036"	27.25"	16.885"
4091603	26" to 27" Sleeve-to-Sleeve Adapter	7 lbs.	1.036"	27.25"	16.885"

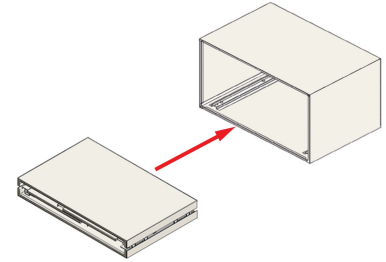

LOUVERS

PART NUMBER	DESCRIPTION	APPROX WT.	DIMENSIONS		
			DEPTH	WIDTH	HEIGHT
6070308	EZ26 Stamped Exterior Louver	2 lbs.	0.394"	25.709"	15.354"
6070309	EZ26 Architectural Exterior Louver	5 lbs.	1.149"	25.687"	15.354"
6070310	EZ26 Insulated Metal Panel	5 lbs.	0.188"	25.375"	14.579"

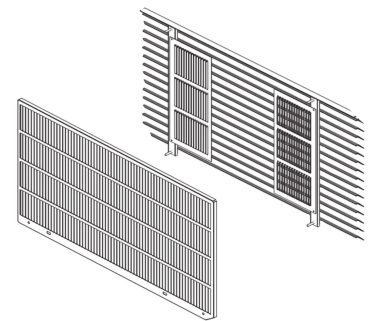

MISCELLANEOUS

PART NUMBER	DESCRIPTION	APPROX WT.	DIMENSIONS		
			DEPTH	WIDTH	HEIGHT
4091136	EZ26 Drain Kit for Wall Sleeve 2400610	1 lb.	N/A	N/A	N/A
6130201	EZ26 Replacement Front Panel (Plastic)	5 lbs.	4.750"	26.00"	15.625"
6041146	EZ26 Replacement Hand Held Remote Control	1 lb.	N/A	N/A	N/A

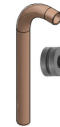

FILTERS

PART NUMBER	DESCRIPTION	APPROX WT.	DIMENSIONS		
			DEPTH	WIDTH	HEIGHT
6080163	EZ26 Plastic Filter, Standard R32	2 lbs.	0.250"	17.00"	10.00"

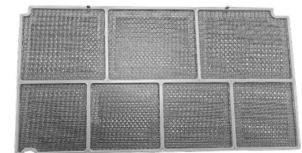

THERMOSTATS

PART NUMBER	DESCRIPTION	APPROX WT.	FEATURES		
			CONNECTION	STAGE	DISPLAY
6041206	Islandaire Non-Programmable, 2 Fan Speed	1.0 lbs.	Wireless	Single	Horizontal
6041210	Islandaire Programmable, 2 Fan Speed	1.0 lbs.	Wireless	Single	Horizontal
6041228	Islandaire Programmable (7 Day/5-1-1 Day/ Non-Programmable), Two Fan Speed	1.0 lbs.	Wired	Single	Horizontal
6041373	Islandaire Wireless, WiFi Programmable	1.0 lbs.	Wireless	Single	Horizontal
6041374	Islandaire Wireless, WiFi (Receiver Only)	1.0 lbs.	N/A	N/A	N/A
6041375	Wet Switch Kit for 6041373 Thermostat	1.0 lbs.	N/A	N/A	N/A



*Islandaire has a policy of continuous improvement of its products and reserves the right to change the materials and specifications without notice.

500 Middle Country Road, St. James, NY 11780 • 1-800-886-2759
 e-mail: sales@islandaire.com • www.islandaire.com
 Ph: 631-471-2900 • Fax: 631-471-2913

Ask your salesman about our
DR. VTAC option!*



*100% conditioned
fresh air

Vertical Unit Available

For New Construction and as
Replacement for:

**GE AZ Vertical and
Friedrich Vert-I-Pak**



500 Middle Country Road • St. James, NY 11780 • 1-800-886-2759
e-mail: sales@islandaire.com • www.islandaire.com
Ph: 631-471-2900 • Fax: 631-471-2913



Locally Represented By: