

## Replacement for the Friedrich Climate Master and Weil-McLain Series 701

Islandaire EZ Series C7 is a replacement for the Friedrich Climate Master and Weil-McLain Model 701 units. Our commercial duty construction with heavy gauge galvanized steel and superior components create an efficient reliable unit. This design eliminates the need for any interior or exterior renovation. Use of the existing wall sleeve-cabinet and louver saves time and money, two very important factors in today's competitive environment! If the need does occur where the room cabinet needs to be replaced, we manufacture these accessories as well.

### FEATURES

- Proudly Assembled in the U.S.A.
- Dual Condensate Drains
- ETL listed product
- Superior Energy Efficiency Ratios (EERs)
- Commercial Duty Construction with Heavy Gauge Galvanized Steel, extensive rust prevention features
- Designed for exact replacement of existing sleeve opening
- High EER (Energy Efficient) Rotary Compressors
- High Efficiency BLDC Evaporator and Condenser Motors
- High-Efficiency Refrigeration Coils Used to Provide Superior Heat Transfer
- Hydrophilic Coated Evaporator Coils
- Units Available as Cooling only, Cooling with Electric Heat, Cooling with Hydronic Heat, or Heat Pumps
- Custom Options Available
- Available with wired and wireless wall thermostats
- NYC MEA Number 358-93-E Vol. II



Voltage/Line Cord	
1 - 115v, 20 Amps	6 - 115v, Hard Wire
2 - 208/230v, 20 Amps	7 - 277v, 20 Amps
3 - 208/230v, 30 Amps	8 - 277v, Hard Wire
4 - 208/230v, Hard Wire	9 - 208/230v, 15 Amps
5 - 115v, 15 Amps	

Cooling Capacity
07 - 7,500 BTU
09 - 9,500 BTU
12 - 12,000 BTU
15 - 15,000 BTU

**Model Type**  
C7- Friedrich Series 701

Functional Options	Functional Option Codes*	
A - None	A - A	L - BD
B - Motorized Damper	B - B	T - C
C - Fan Cycle Switch	C - BC	U - CD
D - Indoor Freeze Protect	D - BCD	2 - D

\*Codes are entered into model number.

**Component**  
EZ - Cooling Chassis

**System Type**  
K - Std. Chassis R32

**Return/Discharge Options**  
1 - Bot. Ret./Top Dis.

**Identity Code**  
0 - Special  
5 - Standard

**EZ 12 K 2 C7 A 1 S 1 5 A A**

**Heating Options**

- A - None Cooling Only
- B - 2.5 kW Elec. Heat (208v - 277v)
- C - 3.4 kW Elec. Heat (208v - 277v)
- D - 4.2 kW Elec. Heat (208v - 277v)
- E - 5.0 kW Elec. Heat (208v - 277v)
- F - Hyd. Fan Cycle W/T-Stat (115v - 277v)
- G - Hyd. With Aquastat (115v - 277v)
- H - Hyd. W/2.5 kW B.U. Heat (208v - 277v)
- I - Hyd. W/3.4 kW Dual Stage (208v - 277v)
- Y - 1.3 kW Elec. Heat (115v Only)

**Hydronic Options**

- 1 - None
- 3 - 115v NC Valve
- 4 - 230v NC Valve
- 5 - 277v NC Valve
- 7 - 115v NO Valve
- 8 - 230v NO Valve
- 9 - 277v NO Valve

**Room Controls**

- E - Wireless Thermostat (specify type when ordering)
- F - Wall Thermostat Interface, Master
- G - Wall Thermostat Interface, Slave
- K - None
- N - Wall Thermostat Interface, Std. Elect. Cntrls
- S - Std. Electronic Controls (Unit Mounted)

**Power Mgt. Options**

- A - None

\*Specifications are subject to change due to ongoing product development.

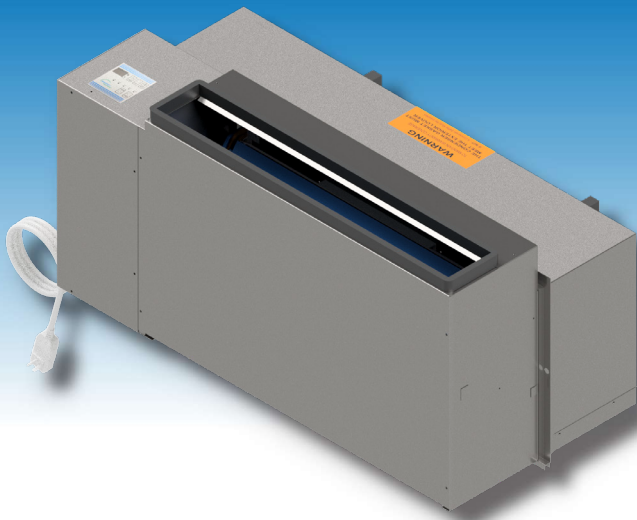

## MODELS

	EZ07			EZ09			EZ12			EZ15	
<b>VOLTS</b>	115	208 / 230	277	115	208 / 230	277	115	208 / 230	277	208 / 230	277
<b>BTUH COOL</b>	7,000	7,000	7,000	9,200	9,200	9,400	11,800	12,000	11,500	14,500	14,500
<b>AMPS</b>	6.48	3.58 / 3.24	2.69	8.87	4.86 / 4.39	3.77	12.22	6.08 / 5.5	4.89	8.73 / 7.89	6.62
<b>WATTS COOL</b>	745	745	745	1,020	1,010	1,045	1,405	1,265	1,355	1,815	1,835
<b>EER</b>	9.4	9.4	9.4	9.0	9.1	9.0	8.4	9.5	8.5	8.0	7.9
<b>CFM HIGH</b>	400	400	400	400	400	400	420	420	420	500	500
<b>CFM LOW</b>	260	260	260	260	260	260	350	350	350	400	400
<b>WEIGHT (LBS)</b>	105	105	105	110	110	110	115	115	115	120	120

Heating Option	Voltage <sup>(1)</sup>	Wattage	BTU/h	Amps <sup>(2)</sup>
B	208	2,045	7,000	9.83
	230	2,500	8,500	10.87
	277	2,500	8,500	9.03
C	208	2,780	9,500	13.37
	230	3,400	11,600	14.78
	277	3,400	11,600	12.27
D	208	3,435	11,700	16.51
	230	4,200	14,300	18.26
	277	4,200	14,300	15.16
E	208	4,090	14,000	19.66
	230	5,000	17,100	21.74
	277	5,000	17,100	18.05
H	208	2,045	7,000	9.83
	230	2,500	8,500	10.87
	277	2,500	8,500	9.03
I	208	2,780	9,500	13.37
	230	3,400	11,600	14.78
	277	3,400	11,600	12.27
Y	115	1,300	4,400	11.30

Where applicable, cooling capacities are specified at conditions of 95 °F DB/75 °F WB (35 °C DB/24 °C WB) outdoor and 80 °F DB/67 °F WB (27 °C DB/19 °C WB) indoor and heating capacities are specified at conditions of 47 °F DB/43 °F WB (8 °C DB/6 °C WB) outdoor and 70 °F DB/60 °F WB (21 °C DB/16 °C WB) indoor in accordance with AHRI 310/380 and CSA C744 standards. Wattage, Amperage, EER, and COP listings include compressor, evaporator motor and condenser fan motor. The above ratings are a typical heat pump style unit.

- (1) Voltage is Single Phase, Alternating Current and R.M.S.  
 (2) Amp values are for heating element only.

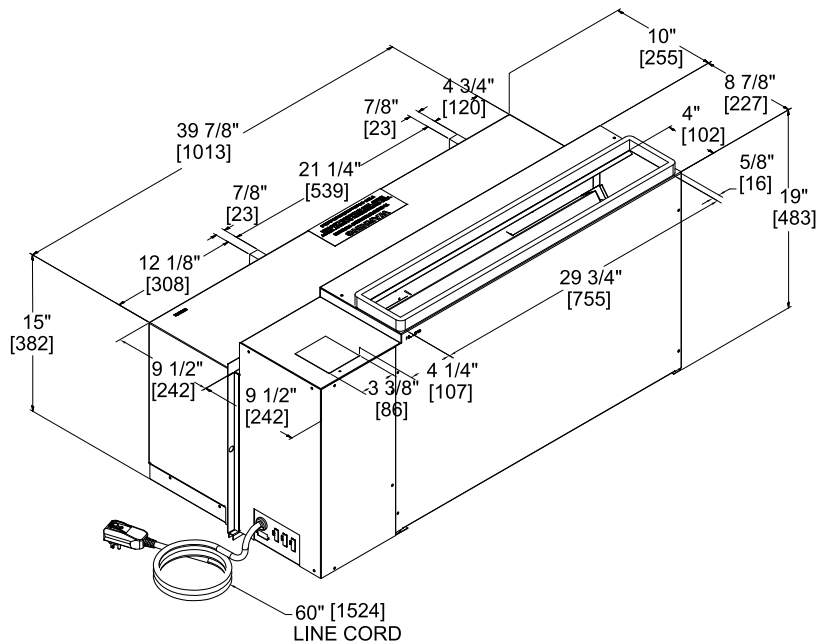

Line Voltage	Maximum Amperage	Wall Socket Configuration	Receptacle Number	Electrical Heat Options
115	12		NEMA 5-15R	1.3
115	16		NEMA 5-20R	1.7
208/230	12		NEMA 6-15R	2.5
208/230	16		NEMA 6-20R	3.6
208/230	24		NEMA 6-30R	4.2 - 5.0
277	16		NEMA 7-20R	2.5 - 4.2
277	24		NEMA 7-30R	5.0

### ENCLOSURES

PART NUMBER	DESCRIPTION	APPROX WT.	DIMENSIONS		
			DEPTH	WIDTH	HEIGHT
Consult Factory	EZC7 Room Enclosures are available in varying depths, in 1" increments, from 10.5" up to 16.5"	20 lbs. (and up)	various	48.000"	21.000"

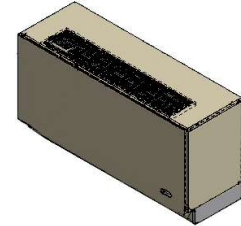

### HYDRONIC COILS

PART NUMBER	DESCRIPTION	APPROX WT.	DIMENSIONS		
			DEPTH	WIDTH	HEIGHT
Consult Factory	-	-	-	-	-

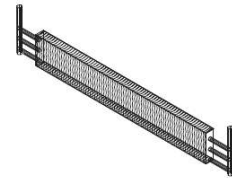

### LOUVERS

PART NUMBER	DESCRIPTION	APPROX WT.	DIMENSIONS		
			DEPTH	WIDTH	HEIGHT
Consult Factory	-	-	-	-	-

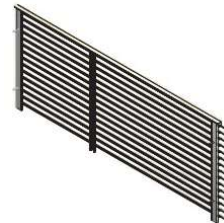

### THERMOSTATS

PART NUMBER	DESCRIPTION	APPROX WT.	FEATURES		
			CONNECTION	STAGE	DISPLAY
6041206	Islandaire Non-Programmable, Two Fan Speed	1.0 lbs.	Wireless	Single	Horizontal
6041210	Islandaire Programmable, Two Fan Speed	1.0 lbs.	Wireless	Single	Horizontal
6041228	Islandaire Programmable (7 Day/5-1-1 Day/ Non-Programmable), Two Fan Speed	1.0 lbs.	Wired	Single	Horizontal
6041373	Islandaire Wireless, WiFi Programmable	1.0 lbs.	Wireless	Single	Horizontal



### FILTERS

PART NUMBER	DESCRIPTION	APPROX WT.	DIMENSIONS		
			DEPTH	WIDTH	HEIGHT
6080000	EZC7 Aluminum Filter, Standard	2 lbs.	0.250"	30.750"	8.500"

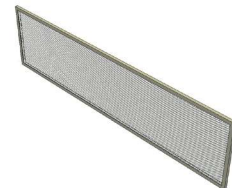

**Ask your salesman about  
our DR. PTAC option!\***



\*100% conditioned  
fresh air

**EZ Series VH Unit  
Available**

Vertical Water Source Hybrid Heat  
Pump, Replacement For:

**CGC InnKeeper/HomeKeeper**

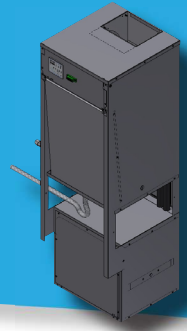

Scan for more information

500 Middle Country Road, St. James, NY 11780 • 1-800-886-2759  
e-mail: [sales@islandaire.com](mailto:sales@islandaire.com) • [www.islandaire.com](http://www.islandaire.com)  
Ph: 631-471-2900 • Fax: 631-471-2913



Locally Represented By:

