



EZ SERIES ED

Replacement for the Singer and McQuay EA, ES and RS Series.

Islandaire EZ Series ED is a replacement for the Singer and McQuay models of EA, ES and RS units. Our commercial duty construction with heavy gauge galvanized steel and superior components create an efficient reliable unit. This design eliminates the need for any interior or exterior renovation. Use of the existing wall sleeve-cabinet and louver saves time and money, two very important factors in today's competitive environment! If the need does occur where the wall sleeve-cabinet front panel and/or louver needs to be replaced, we manufacture these accessories as well.

FEATURES

- Proudly Made in the U.S.A.
- ETL listed products
- Superior Energy Efficiency Ratios (EERs)
- Commercial Duty Construction with Heavy Gauge Galvanized Steel
- Designed for exact replacement of existing sleeve opening
- Energy Efficient Rotary Compressors
- P.S.C. Evaporator and Condenser Motors
- High-Efficiency Refrigeration Coils Used to Provide Superior Heat Transfer
- Units Available as Cooling only, Cooling with Electric Heat, Cooling with Hydronic Heat, or Heat Pumps
- Custom Options Available
- Available with State-of-the-Art Digital *Intellitemp™* Control System
- Available with wired and wireless wall thermostats
- NYC MEA Number 358-93-E

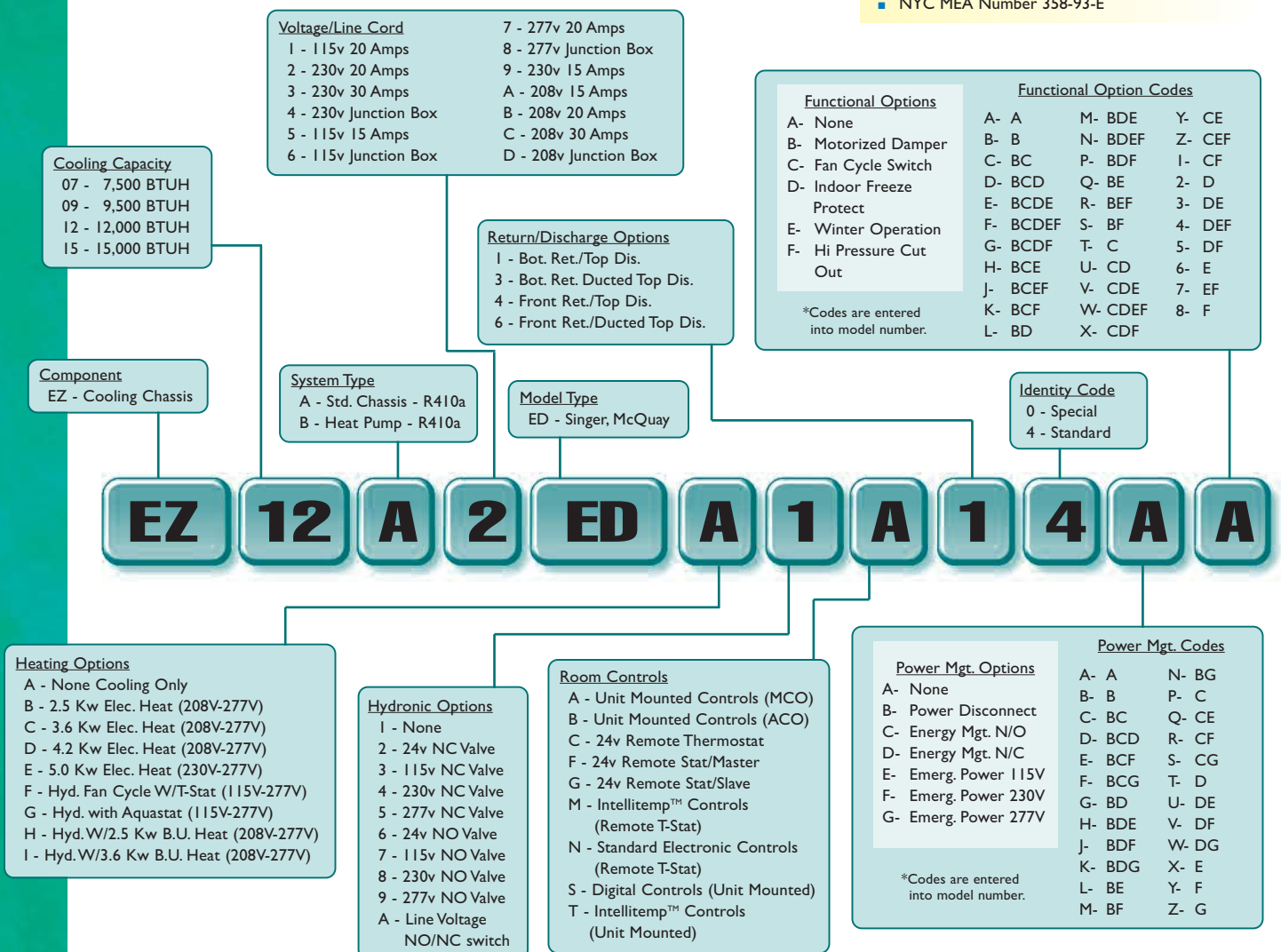

*Specifications are subject to change due to ongoing product development.



MODELS																
	EZ07				EZ09				EZ12				EZ15			
VOLTS	115	230	208	277	115	230	208	277	115	230	208	277	230	208	277	
BTUH COOLING	7,000	7,000	6,800	7,000	9,500	9,500	9,300	9,500	12,200	12,200	12,000	12,200	15,000	14,800	15,000	
AMPS	6.76	3.30	3.70	2.81	8.76	4.38	4.85	3.64	11.66	5.83	6.45	4.84	7.99	8.9	6.63	
WATTS COOLING	731	723	723	731	945	986	986	945	1,247	1,328	1,328	1,247	1,768	1,768	1,671	
EER	9.58	9.68	9.41	9.58	10.05	9.63	9.43	10.05	9.78	9.19	9.04	9.78	8.48	8.37	8.98	
CFM HIGH	340	340	320	340	400	400	380	400	400	400	380	400	460	440	460	
CFM LOW	260	260	240	260	260	260	240	260	340	340	320	340	340	320	340	
BTUH HEATING	7,100	7,100	6,900	7,100	9,300	9,300	9,100	9,300	11,400	11,400	11,200	11,400	14,300	14,200	14,800	
WATTS HEATING	751	749	749	751	884	864	864	884	1,281	1,258	1,258	1,281	1,646	1,646	1,715	
C.O.P.	2.77	2.78	2.70	2.77	3.09	3.16	3.09	3.09	2.61	2.66	2.61	2.61	2.55	2.53	2.53	

Heating Option	Voltage (1)	Wattage	B.T.U.s (2)	Amps (3)
B	208	2,050	7,000	10.46
	230	2,500	8,535	11.47
	277	2,500	8,535	9.63
C	208	2,950	10,070	14.78
	230	3,600	12,290	16.25
	277	3,600	12,290	13.60
D	208	3,433	11,720	17.10
	230	4,200	14,330	18.86
	277	4,200	14,330	15.76
E	208	4,100	14,000	20.31
	230	5,000	17,070	22.34
	277	5,000	17,070	18.65

(1) Voltage is Single Phase, Alternating Current and R.M.S. (2) Heating Capacity (B.T.U./Hr.) based on indoor blower motor and heating elements. (3) Amp values are a combination of indoor blower motor and heating elements.

Line Voltage	Maximum Amperage	Wall Socket Configuration	Receptacle Number	Electrical Heat Options
115	16		NEMA 5-20R	N/A
208/230	12		NEMA 6-15R	N/A
208/230	16		NEMA 6-20R	2.5 - 3.6
208/230	24		NEMA 6-30R	4.2 - 5.0
277	16		NEMA 7-20R	2.5 - 5.0

Heating capacities specified in accordance with ARI standard 380-82 at conditions of 47°F WB outdoor and 70°F DB/60°F WB indoor. Wattage, Amperage, COP, EER listings include compressor, evaporator motor and condenser fan motor. Cooling capacities specified in accordance with ARI standard 380-82 at conditions of 95°F DB/75°F WB outdoor and 80°F DB/67°F WB indoor.

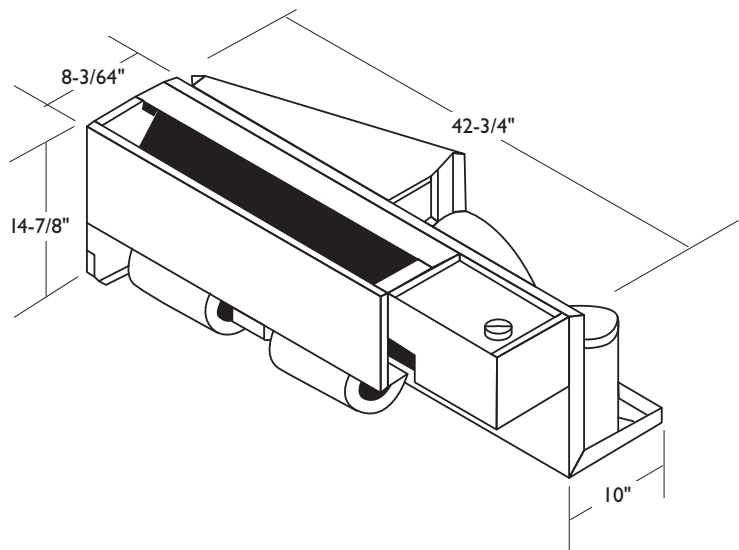

EZ SERIES ED

Unit Accessories

ENCLOSURES

PART NUMBER	DESCRIPTION	APPROX. WT.	DIMENSIONS		
			DEPTH	WIDTH	HEIGHT
4082429-101	EZED Enclosure Assembly Hydronic Heat w/ Telescopic base, Front Return, Custom	30 lbs.	11.000"	54.875"	21 - 25"

WALL SLEEVES/CABINETS

PART NUMBER	DESCRIPTION	APPROX. WT.	DIMENSIONS		
			DEPTH	WIDTH	HEIGHT
2400227-73	EZED Wall Sleeve Assembly without Front Panel	40 lbs.	20.000"	44.750"	16.438"
2400354-73	EZED Wall Sleeve Assembly without Front Panel	40 lbs.	20.750"	44.750"	16.438"
4083479-73	EZED Front Panel, type EA/RS	40 lbs.	.750"	43.756"	15.627"

DUCT ASSEMBLIES

PART NUMBER	DESCRIPTION	APPROX. WT.	DIMENSIONS		
			LENGTH	WIDTH	HEIGHT
4082407-73	EZED Duct Assembly, Standard w/ Plenum	20 lbs.	N/A	N/A	N/A
4082410-73	EZED Duct Extension Assembly, 3'	10 lbs.	N/A	N/A	N/A
4083561-73	EZED Duct Extension Assembly, 6.00'	15 lbs.	N/A	N/A	N/A

HYDRONIC COILS

PART NUMBER	DESCRIPTION	APPROX. WT.	DIMENSIONS		
			LENGTH	WIDTH	HEIGHT
6030153	EZED Hydronic Coil, Top Mounted	20 lbs.	41.346"	6.000"	0.540"
6030243	EZED Hydronic Coil Assembly, Custom	20 lbs.	30.750"	5.000"	0.886"

LOUVERS

PART NUMBER	DESCRIPTION	APPROX. WT.	DIMENSIONS		
			DEPTH	WIDTH	HEIGHT
6070079	EZED Exterior Architectural Louver, Standard	10 lbs.	1.063"	44.750"	15.939"

THERMOSTATS

PART NUMBER	DESCRIPTION	APPROX. WT.	FEATURES		
			CONNECTION	STAGE	DISPLAY
6040523	Islandaire Non-Programmable Thermostat	3 lbs.	Wired	Single	Horizontal
6040730	White-Rogers Programmable 5/2 days T-Stat	3 lbs.	Wired	Single	Horizontal
6040942	Islandaire Programmable Thermostat	3 lbs.	Wired	Single	Horizontal
6040824	Islandaire EZ Touch IR Non-Program T-Stat	3 lbs.	Infrared	Single	Vertical
6040935 - 6040936	Telkonet EcoWave Thermostat Kit	5 lbs.	Wireless	Single	Vertical

FILTERS

PART NUMBER	DESCRIPTION	APPROX. WT.	DIMENSIONS		
			DEPTH	WIDTH	HEIGHT
6080000	EZED Standard Filter 30.750 X 8.50	2 lbs.	.250"	30.750"	8.500"
6080003	EZED Custom Filter 18 X 12	2 lbs.	.250"	18.000"	12.000"
6080004	EZED Long Filter 41.625 X 5.25	3 lbs.	.250"	41.625"	5.250"
6080005	EZED Long Filter, Thick, 41.625 X 5.25	4 lbs.	.468"	41.625"	5.250"

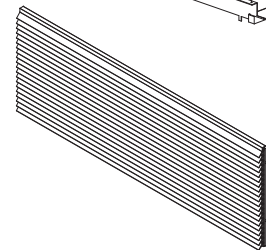
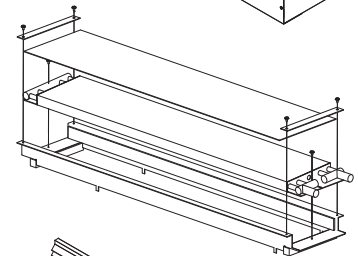
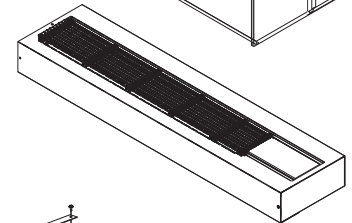
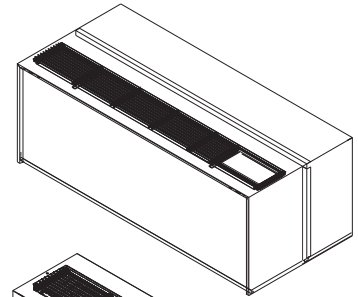
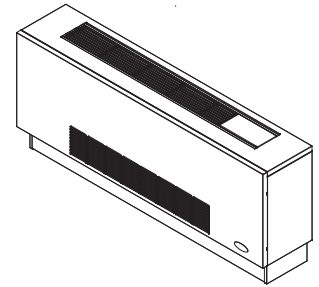

Ask your salesman about
our DR. PTAC option! *



*100% conditioned
fresh air

NEW!
Vertical Unit Available

For New Construction and
as Replacement for:

**GE AZ Vertical, Friedrich Vert-I-Pak
and First Company SPX**



22 Research Way, East Setauket, NY 11733 • 1-800-886-2759
e-mail: sales@islandaire.com • www.islandaire.com
Ph: 631-471-2900 • Fax: 631-471-2913



Locally Represented By: